

Code no. 60-090
STRONG STAINLESS STEEL BUTT HINGE

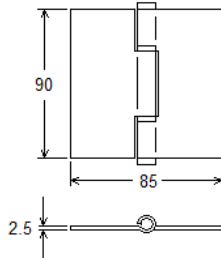

Code no. 60-090A
STRONG BUTT HINGE

Strong sharp edge stainless steel butt hinge with riveted or loose pins stainless steel pin
Without holes

Stainless steel grade 304 (1.4301)

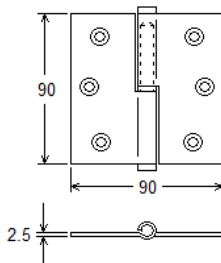

Code no. 60-090B
STRONG ROLLED LIFT OFF BUTT HINGE

Strong sharp edge stainless steel butt hinge with riveted or loose pins stainless steel pin
With countersunk holes

Stainless steel grade 304 (1.4301)

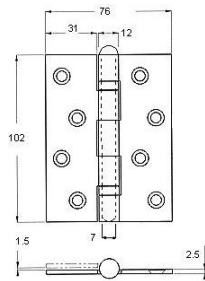

Code no. 60-090C
HEAVY DUTY BUTT HINGE WITH CSK HOLES AND THRUST BEARINGS

Rolled strong sharp edge stainless steel butt hinge with fixed or loose stainless steel pin
Loose pin can be supplied with c-clip
With countersunk holes

Stainless steel grade 304 (1.4301)

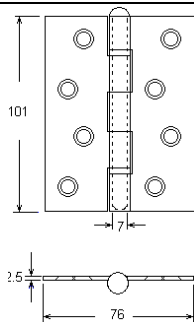

Code no. 60-090D
HEAVY DUTY BUTT HINGE WITH CSK HOLES AND THRUST BEARINGS

Rolled strong sharp edge stainless steel butt hinge with fixed or loose stainless steel pin
Loose pin can be supplied with c-clip
With countersunk holes

Stainless steel grade 304 (1.4301)

Dimensions in mm

Code no. 60-090
STRONG STAINLESS STEEL HINGES

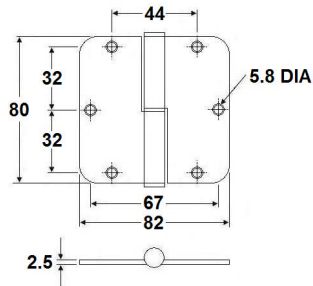

Code no. 60-090M2L

L 80 x B 82 x 2.5, Left hand

Code no. 60-090M2R

L 80 x B 82 x 2.5, Right hand

LIFT OFF BUTT HINGE

Rolled radius edge stainless steel butt hinge with fixed stainless steel pin

With countersunk holes

Stainless steel grade 304

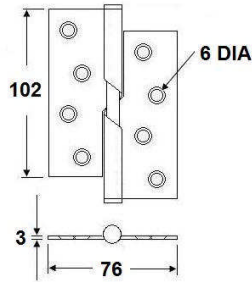

Code no. 60-090P2L

L 102 x B 76 x 3, Left hand

Code no. 60-090P2R

L 102 x B 76 x 3, Right hand

RISING BUTT HINGE

Strong sharp edge stainless steel butt hinge with fixed stainless steel pin and countersunk holes

Stainless steel grade 304

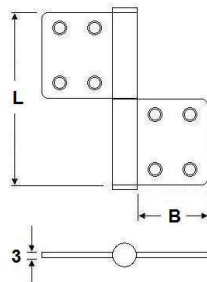

Code no. 60-090P3L

L 102 x B 48 x 3, Left hand

Code no. 60-090P3R

L 125 x B 52 x 3, Right hand

STAINLESS STEEL FLAG HINGE

Universal stainless steel flag hinge with fixed stainless steel pin

With double countersunk holes

Stainless steel grade 304

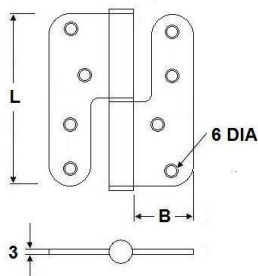

Code no.60-090P4L

L 102 x B 89 x 3, Left hand

Code no,60-090P4R

L 102 x B 89 x 3, Right hand

STRONG ROLLED LIFT OFF BUTT HINGE

Rolled strong radius edge stainless steel butt hinge with fixed stainless steel pin

With double countersunk holes

Stainless steel grade 304

Dimensions in mm

Code no. 60-090
STRONG STAINLESS STEEL HINGES

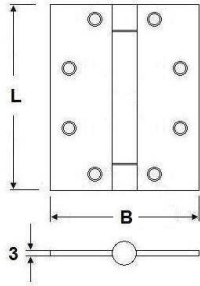

Code no. 60-090P5 L 102 x B 76 x 3, Square corner
Code no. 60-090P6 L 102 x B 102 x 3, Square corner
Code no. 60-090P7 L 102 x B 102 x 3, Radius corner

SINGLE ACTION SPRING HINGE

Rolled strong sharp edge stainless steel spring hinge with fixed stainless steel pin. Fire tested to BS EN 1634-1: 2000 FD60 Timber. Adjustable tension. Stainless steel grade 304

Code no. 60-090P8

BUTT HINGE WITH THRUST BEARINGS

Rolled strong sharp edge stainless steel butt hinge with countersunk holes

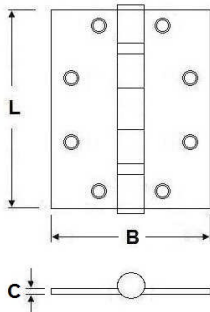

Specification:
 Pozi Drive Screws
 Security Pinned Caps
 BS EN 1634-1:2000 Fire Tested
 FD60 Timber
 FD240 Steel
 BS EN 1935:2002 Performance Tested
 Certifire CF336

Available Sizes & Finishes:

Size (mm)			BS EN 1935	FIRE TESTED	CERTIFIRE	CODE NO.
L	B	C				
76	51	2	7	V	X	60-090P8D
102	76	2.5		X	X	60-090P8E
102	76	3	11	V	V	60-090P8F
102	76	3	13	V	V	60-090P8G
102	76	3	13	V	V	60-090P8G316
127	102	3		X	X	60-090P8H

Intumescent hinge pads (square or rounded corners) sold separately

Dimensions in mm

Code no. 60-090
STRONG STAINLESS STEEL HINGES

Code no. 60-090P9

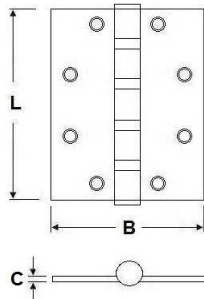

BUTT HINGE WITH 4 THRUST BEARINGS

Rolled strong sharp edge stainless steel butt hinge with countersunk holes

Specification:
4 thrust bearings
Pozi Drive Screws
Security Pinned Caps
BS EN 1634-1:2000 Fire Tested
FD60 Timber
FD240 Steel
BS EN 1935 Performance Tested
Certifire CF336

Available Sizes & Finishes:

Size (mm)			BS EN 1935	FIRE TESTED	CERTIFIRE	CODE NO.
L	B	C				
102	76	3	11	V	V	60-090P9

Code no. 60-090P12

BUTT HINGE WITH THRUST BEARINGS, COLOUR COATED

Rolled strong sharp edge stainless steel butt hinge with countersunk holes, colours: WHITE, RED or BLACK

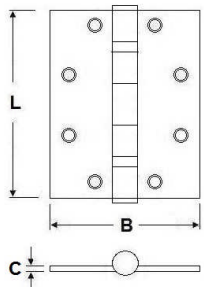

Specification:
Pozi Drive Screws
Security Pinned Caps
BS EN 1634-1:2000 Fire Tested
FD60 Timber
FD240 Steel
BS EN 1935:2002 Performance Tested
Certifire CF336

Available Sizes & Finishes:

Size (mm)			BS EN 1935	FIRE TESTED	CERTIFIRE	CODE NO.
L	B	C				
76	51	2	7	X	X	60-090P12A
102	76	3	13	V	V	60-090P12B

Dimensions in mm

Code no. 60-090
STRONG STAINLESS STEEL HINGES

Code no. 60-090P14

BUTT HINGE

Rolled strong sharp edge stainless steel butt hinge with countersunk holes

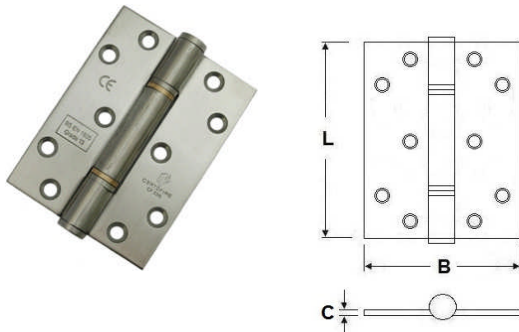

Specification:
Self Lubricating, Maintenance Free
Pozi Drive Screws
Security Pinned Caps
BS EN 1634-1:2000 Fire Tested
FD60 Timber
FD240 Steel
BS EN 1935 Performance Tested
Certifire CF336

Available Sizes & Finishes:

Size (mm)			BS EN 1935	FIRE TESTED	CERTIFIRE	CODE NO.
L	B	C				
102	76	3	13	V	V	60-090P14

Code no. 60-090P15

BUTT HINGE WITH ROUND CORNER

Rolled strong sharp edge stainless steel butt hinge with countersunk holes

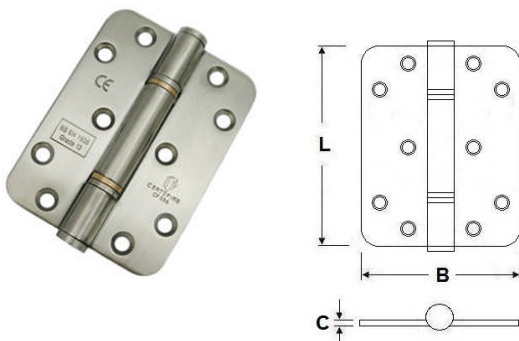

Specification:
Self Lubricating, Maintenance Free
Pozi Drive Screws
Security Pinned Caps
BS EN 1634-1:2000 Fire Tested
FD60 Timber
FD240 Steel
BS EN 1935:2002 Performance Tested
Certifire CF336

Available Sizes & Finishes:

Size (mm)			BS EN 1935	FIRE TESTED	CERTIFIRE	CODE NO.
L	B	C				
102	76	3	13	V	V	60-090P15

Dimensions in mm

Code no. 60-090
STRONG STAINLESS STEEL HINGES

Code no. 60-090P17

SECURITY HINGE

Rolled strong sharp edge stainless steel butt hinge with countersunk holes

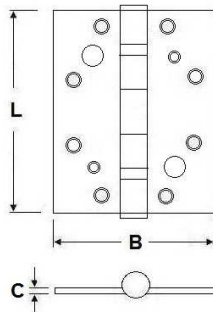

Specification:
2 Security Hinge Bolts
Pozi Drive Screws
Security Pinned Caps
BS EN 1634-1:2000 Fire Tested
FD60 Timber
FD240 Steel
BS EN 1935 Performance Tested

Available Sizes & Finishes:

Size (mm)			BS EN 1935	FIRE TESTED	CERTIFIRE	CODE NO.
L	B	C				
102	76	3	13	V	V	60-090P17C
102	102	3	13	V	X	60-090P17D

Code no. 60-090P18

STAINLESS STEEL REBATED HINGE

Rolled strong sharp edge stainless steel butt hinge with countersunk holes

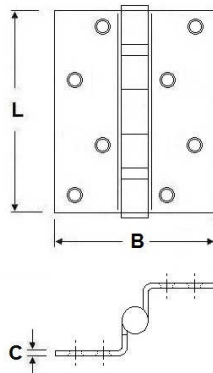

Specification:
Pozi Drive Screws
Security Pinned Caps, LEFT HANDED

Available Sizes & Finishes:

Size (mm)			CODE NO.
L	B	C	
102	76	3	60-090P18

Dimensions in mm

Code no. 60-090
STRONG STAINLESS STEEL HINGES

Code no. 60-090P20

STAINLESS STEEL HINGES WITH WASHERS

Rolled strong sharp edge stainless steel butt hinge with countersunk holes

Specification:
Pozi Drive Screws
BS EN 1634-1:2000 Fire Tested
BS EN 1935:2002 Performance Tested

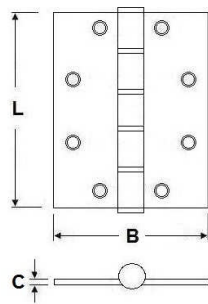

Available Sizes & Finishes:

Size (mm)			BS EN 1935	FIRE TESTED	CODE NO.
L	B	C			
76	51	2		X	60-090P20A
102	67	2	7	V	60-090P20B
102	76	2	7	V	60-090P20C

Code no. 60-090P21

STAINLESS STEEL PLAIN BEARING HINGE

Rolled strong sharp edge stainless steel butt hinge with countersunk holes

Specification:
Pozi Drive Screws
BS EN 1634-1:2000 Fire Tested
BS EN 1935:2002 Performance Tested

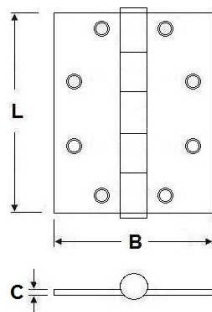

Available Sizes & Finishes:

Size (mm)			BS EN 1935	FIRE TESTED	CODE NO.
L	B	C			
76	51	2		X	60-090P21J
102	76	2	7	V	60-090P20K

Dimensions in mm